

# Instructions

for cleaning,  
sterilization,  
inspection and  
maintenance



of Trauma & Extremities (T&E) medical devices

# Contents

|    |  |    |
|----|--|----|
| 1. | Introduction   | 3  |
| 2. | Processing instructions                              | 4  |
| 3. | Cleaning   | 5  |
|    | Point of use, transport and preparation for cleaning | 8  |
|    | Pre-cleaning   | 10 |
|    | Automated cleaning and disinfection                  | 12 |
|    | Manual cleaning                                      | 13 |
|    | Manual disinfection                                  | 15 |
|    | Inspection   | 16 |
|    | End of life definition                               | 17 |
| 4. | Packaging  | 18 |
| 5. | Sterilization  | 19 |
| 6. | Storage before use                                   | 21 |
| 7. | Manufacturers of Stryker T&E medical devices         | 21 |
| 8. | References   | 21 |

## **Appendix 1**

|  |   |    |
|--|---|----|
|  | Cleaning detergents and disinfectants used during validation of the processing instructions | 22 |
|--|---|----|

## **Appendix 2**

|  |   |    |
|--|---|----|
|  | Guidelines to check proper functionality of Stryker T&E medical devices | 23 |
|--|---|----|

The instructions for use, operative techniques, cleaning instructions, patient information leaflets and other associated labeling may be requested online at [www.ifu.stryker.com](http://www.ifu.stryker.com), [www.stryker.com](http://www.stryker.com) or [www.patientinfo.stryker.com](http://www.patientinfo.stryker.com).

# 1. Introduction

This document is created based on the requirements of EN ISO 17664, Processing of health care products – Information to be provided by the medical device manufacturer for the processing of medical devices. Medical devices include all products in scope such as instruments, implants and trays. This document is intended to give general guidance on how medical devices supplied by one of the Stryker Trauma & Extremities (T&E) manufacturing locations (see manufacturer addresses in section 7) may be processed to prepare them for use. It also gives instructions for inspection to determine when an instrument has reached the end of its serviceable life and must be replaced.

This document is provided in conjunction with the Instructions for Use (IFU), which come with the products, and, if applicable, with the assembly/disassembly instructions for multi-component instruments, which must be disassembled prior to cleaning. Stryker T&E has demonstrated the processes described in these instructions to be effective. Equipment, operators, cleaning detergents and procedures may contribute to the efficacy of the processing. Alternative methods of processing may also be suitable. In each case, the health care facility has final responsibility for the implementation of validated procedures to achieve cleanliness and sterility of reusable devices. In the event of conflicting national cleaning and sterilization requirements, these shall prevail over Stryker T&E's recommendations. This applies particularly to the different procedures for inactivation of prions.

## WARNING

- Single-use implants and instruments should not be re-sterilized, unless otherwise specified in the corresponding IFU of the medical device.
- Single-use devices cannot be reused, as they are not designed to perform as intended after the first usage. Mechanical, physical or chemical properties of single-use devices may be compromised after first usage. In this case, the safety and performance of the devices are not supported by the manufacturer, compliance to relevant specifications cannot be ensured.
- Implants which have already been used in a surgically invasive manner, even if implanted only partly or temporarily during the surgical procedure, shall not be reprocessed for reuse.
- In the event of contamination, or expiration of shelf life or in the case of a medical device supplied non-sterile, the medical device must be subjected to an appropriate cleaning process and sterilized by means of a validated sterilization procedure before use, unless specified otherwise in the product labeling or respective IFU. If a sterile medical device is also sold non-sterile, the sterile medical device can be put into the dedicated labeled location of the non-sterile medical device in the tray and then be sterilized by means of a validated sterilization procedure before use.
- Multicomponent instruments must be disassembled for cleaning. Please refer to the corresponding assembly/disassembly instructions.

## NOTICE

- Avoid cross contamination of implants with soiled instruments.
- Neutral pH, enzymatic, and alkaline (pH ≤ 10.9) cleaning detergents are recommended and preferred for cleaning reusable devices. Alkaline detergents with pH ≥ 10.9 may be used to clean stainless steel and polymer instruments in countries where required by law or local ordinance; or where prion diseases such as Transmissible Spongiform Encephalopathy (TSE) and Creutzfeldt-Jakob Disease (CJD) are a concern. It is critical that alkaline cleaning detergents are thoroughly neutralized and completely rinsed from the devices.
- The devices should be carefully inspected after processing with alkaline detergents. If proper functionality is no longer given, the devices should be disposed and replaced.
- It is important to select enzymatic detergents intended for breakdown of blood, body fluids and tissues. Some enzymatic detergents are specifically for breakdown of fecal matter or other organic contaminants and may not be suitable for use with medical devices.
- For the use of the Stryker EU Mesh Baskets please consult the instructions for use of the manufacturer (Paragon Medical) for additional information.

# 2. Processing instructions

The sequence of steps required to prepare medical devices for re-use or to prepare new devices for initial use are summarized in the in the flowchart.

Detailed instructions for each step are given on the following pages.

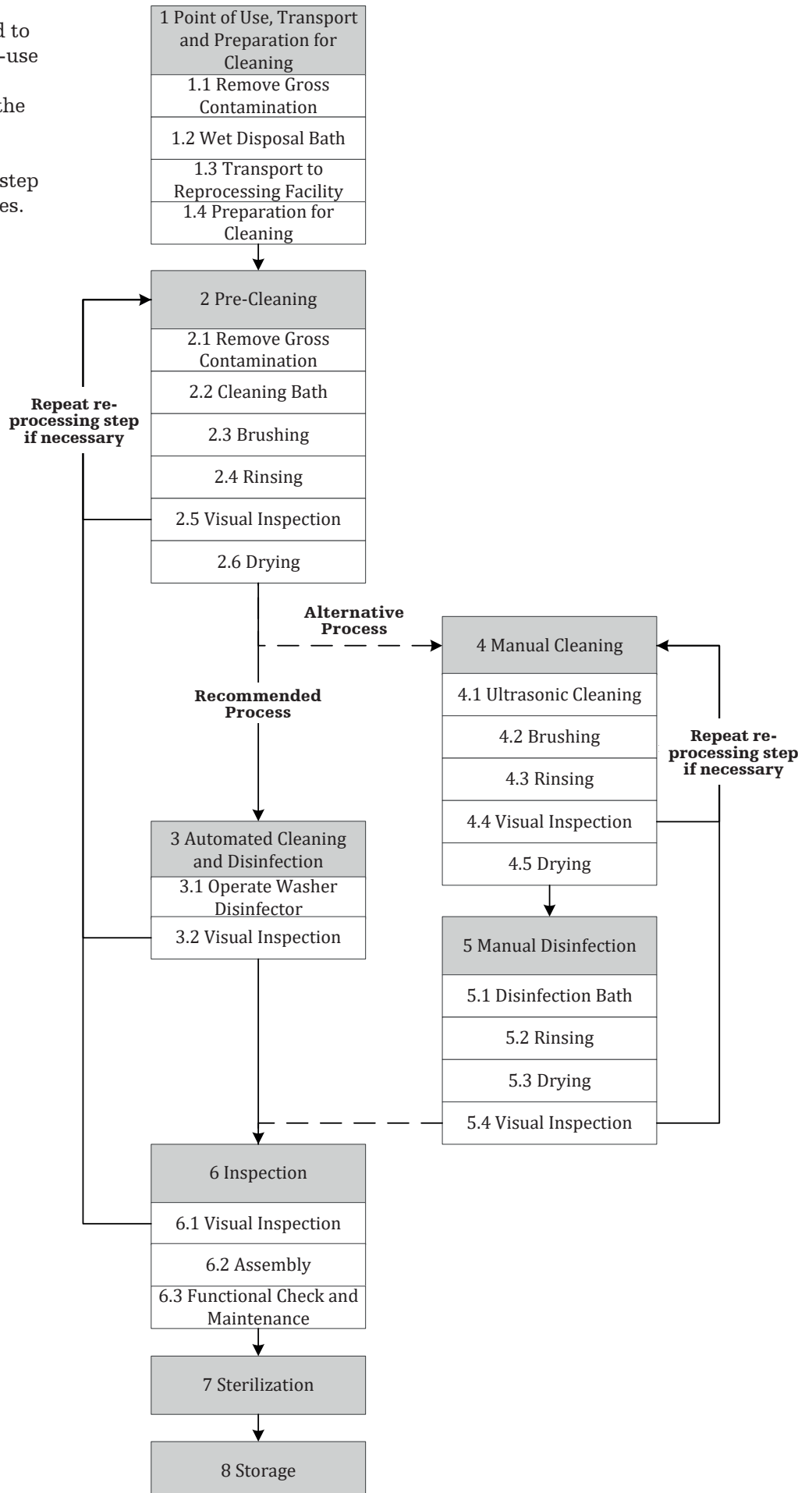

# 3. Cleaning

Two methods of cleaning Stryker T&E's medical devices are provided in these instructions:

- an automated method using a washer disinfectant and
- a manual method.

Whenever possible the automated method should be preferred. The automated cleaning process is more reproducible and therefore more reliable, and staff is less exposed to the contaminated devices and the cleaning detergents used.

Whichever method is used, staff should use suitable protective clothing and equipment at all times. In particular take note of the instructions provided by the cleaning detergent manufacturer for correct handling and use of the product.

The recommended concentrations and times for device immersion in the cleaning solutions and/or disinfectants given by the detergent manufacturers shall be observed.

If these concentrations and times are exceeded significantly, discoloration or corrosion could occur with some materials. This could also happen if rinsing after cleaning and/or disinfecting is insufficient.

For cleaning or disinfecting medical devices only specifically formulated cleaning detergents and/or disinfectants should be used.

As not all cleaning detergents and disinfectants may be available around the globe, criteria for the selection of appropriate detergents are provided in Appendix 1. A list of cleaning detergents and disinfectants which Stryker T&E used in the validation of these processing instructions is also provided in Appendix 1. Stryker T&E does not recommend any specific cleaning and/or disinfection detergent. A general description of suitable detergents is included in Appendix 1.

The quality of the water used for diluting cleaning detergents and/or disinfectants and for rinsing medical devices should be carefully considered. Demineralized water is recommended for the dilution of cleaning and/or disinfection detergents.

For rinsing purposes, only sterile water or germ-free water with less than 10 germs/ml or endotoxin-free water with less than 0.25 endotoxins/ml should be used, e.g. purified water or highly purified water. Mineral residues from hard water as well as higher contamination with microorganisms and endotoxins can result in staining of the device or prevent effective cleaning and decontamination.

# 3. Cleaning

Based on the design features of Stryker T&E medical devices specific challenges and requirements are set for a successful cleaning process. Please consider these special instructions for the respective product groups as described in the table below. Please also note the guidelines on functional checks, preventive maintenance and end of life criteria in Appendix 2.

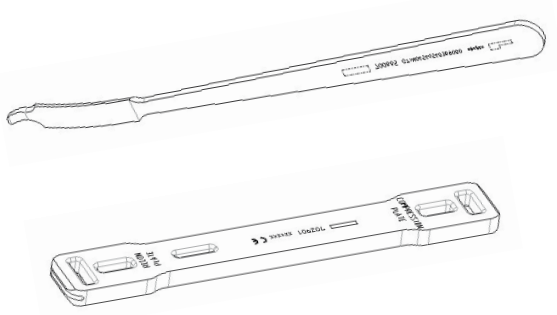
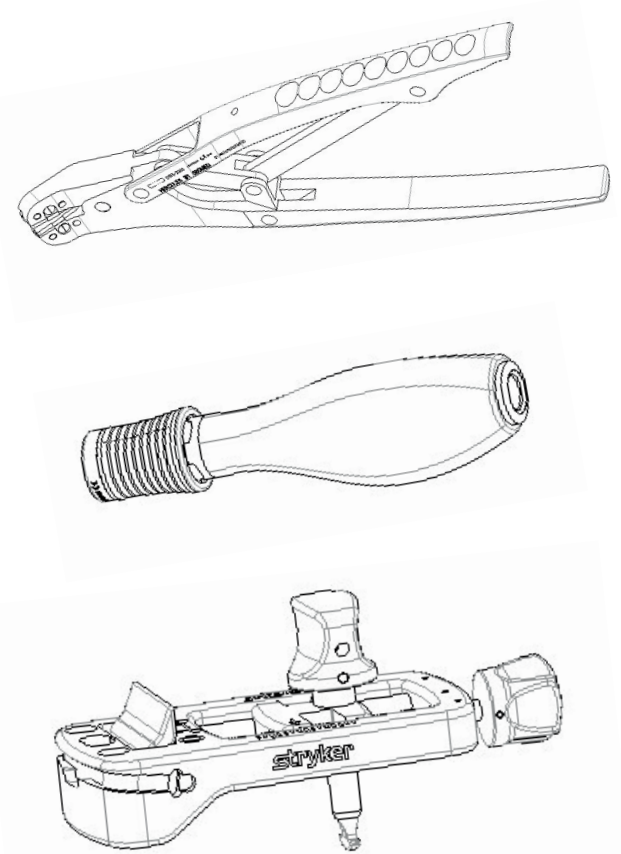
|  |  |
|--|--|
| <p><b>Simple medical devices</b><br/>         Devices with no demanding features or special requirements regarding the cleaning process, e.g. simple bending irons, screwdriver blades.</p>  |  |
|   | <p>N/A</p>   |
| <p><b>Complex / multi-component medical devices with challenging features</b><br/>         Devices which have demanding design features, such as cannulations, blind holes, crevices, sharp edges, moving parts, shielded surfaces and/or consist of multiple components. Examples: forceps, targeting devices, handles with mechanism. Typical devices are shown in Appendix 2.</p> |  |
|   | <p><b>CAUTION</b></p> <ul style="list-style-type: none"> <li>• Please proceed carefully to avoid any injury. Bone cutting instruments may feature sharp edges.</li> <li>• These devices may consist of two or more components. Make sure to disassemble the device prior to cleaning, where indicated. See instructions provided in the operative technique or separate information available from your Stryker representative.</li> </ul> |

# 3. Cleaning

## Medical devices with flexible shaft

Devices which feature a flexible shaft, e.g. reamer shaft, flexible screwdriver.  
Typical devices are shown in Appendix 2.

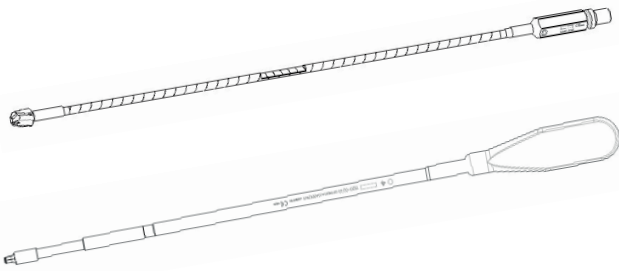

Reusable medical devices with a flexible shaft are considered as demanding instruments regarding cleaning. In each case, the instructions for cleaning, sterilization, inspection and maintenance shall be strictly followed.

The automated cleaning process should be preferred over the manual method and used whenever possible. The automated cleaning process has a higher reproducibility and reliability.

Qualification of cleaning and disinfection process: In order to qualify the described automated and manual method, the flexible screwdriver and the reamer shafts were subjected to standardized microbiological efficiency control studies. The devices were contaminated under worst case conditions with an artificial soil containing spores. After reprocessing of the devices according to the instructions the reduction of the spores was determined. The automated and manual method were qualified separately. A reduction of the spore count of at least 3 log steps is considered as acceptable<sup>1</sup>. In all test series the devices achieved a log reduction of at least 3.3 log steps. Based on the acquired data both cleaning processes were successfully qualified in conjunction with the flexible screwdriver and the reamer shafts<sup>2</sup>.

**NOTICE** In order to avoid damage of the flexible reamer shaft do not overbend the shaft. As a reference the maximum bending diameter should not exceed the length divided by 2, see also Appendix 2.

**CAUTION** Remove contamination from shafts right after use to avoid incrustation, which will be baked permanently in subsequent sterilizations.

<sup>1</sup> AAMI TIR 30:2011, section 7.5  
<sup>2</sup> Test Reports #083333-10A/B, #114764-10A/B, Medical Device Services GmbH, Gilching, Germany. Reports available on request.

## Trays and inserts

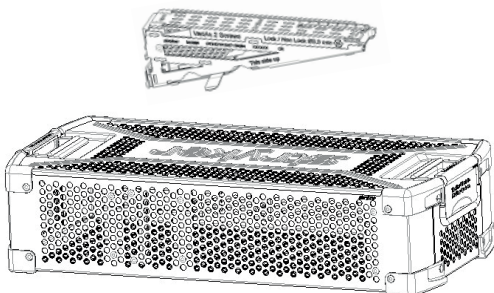

Stryker T&E trays are intended for sterilization, transport and storage of medical devices. They are not designed for cleaning and disinfection in the fully equipped state. The devices must be removed from the tray for adequate cleaning results.

### 3. Cleaning

#### Point of use, transport and preparation for cleaning

| Sub-step                          | Description / Equipment / Parameters  | Additional information   |
|-----------------------------------|---|--|
| 1.1<br>Remove gross contamination | Required equipment and media: <ul style="list-style-type: none"> <li>• Absorbent lint-free single-use paper wipes</li> <li>• Running water: Sterile or germ-free with less than 10 germs/ml or endotoxin-free with less than 0.25 endotoxins/ml, e.g. purified water or highly purified water</li> <li>• Syringes: Volume 1 to 50 ml depending on the size of the feature to be rinsed</li> </ul> | -  |
|                                   | Directly after application, remove gross contamination using absorbent lint-free single-use paper wipes.  | The cleaning process shall be initiated directly after application (within a maximum of 2 hours postoperatively) to avoid drying of the contamination.   |
|                                   | Rinse the device under running water for at least 1 minute. Bend and rotate flexible shafts during rinsing to remove contamination between the windings.  | -  |
|                                   | Rinse cannulations, blind holes, hinges, joints and similar features at least three times using a syringe.  | -  |
| 1.2<br>Wet disposal bath          | Required equipment and media: <ul style="list-style-type: none"> <li>• Disinfectant</li> <li>• Demineralized water</li> <li>• Break-proof, disinfectable, closed container</li> </ul>   | The disinfectant solution shall meet the requirements of Appendix 1.   |
|                                   | Prepare an effective aldehyde-free disinfectant solution according to the specifications of the detergent's manufacturer using demineralized water in an appropriate container.   | The temperature of the solution shall be less than 40 °C to avoid protein fixation.  |
|                                   | Carefully put the device into the container to prevent organics from drying. Open devices with joints and moving parts. Fully immerse the device in the disinfectant solution.  | <div style="background-color: yellow; border: 1px solid black; padding: 2px;"><b>⚠ CAUTION</b></div> <ul style="list-style-type: none"> <li>• Please proceed carefully to avoid any injury. Bone cutting instruments may feature sharp edges.</li> <li>• Always treat the instrument carefully to avoid alterations to the geometry.</li> </ul> <p>Do not mix heavy devices with fragile ones in the container to avoid mechanical damage.</p> <p>Ensure that all surfaces are wetted with disinfection solution:</p> <ul style="list-style-type: none"> <li>• Use a syringe to moisten all parts of the device, incl. cannulations, hinges and other shielded surfaces.</li> <li>• Ensure that no air is trapped within the features of the device.</li> <li>• Fully move devices with joints and moving parts at least 3 times.</li> </ul> |



### 3. Cleaning

| <b>Sub-step</b>                    | <b>Description / Equipment / Parameters</b>  | <b>Additional information</b>  |
|------------------------------------|--|--|
| 1.3<br>Transport                   | Carefully transport the devices in the container to the point where cleaning is to be performed. | -  |
| 1.4<br>Preparation<br>for cleaning | Disassemble the device where indicated.  | See instructions provided in the operative technique or separate information available from your Stryker representative. |

# 3. Cleaning

## Pre-cleaning

| Sub-step                          | Description / Equipment / Parameters  | Additional information   |
|-----------------------------------|---|--|
| 2.1<br>Remove gross contamination | Required equipment and media: <ul style="list-style-type: none"> <li>• Cleaning detergent</li> <li>• Demineralized water</li> <li>• Container</li> <li>• Syringes</li> <li>• Absorbent lint-free single-use paper wipes</li> </ul>  | Use a cleaning detergent intended for manual cleaning, which meets the criteria given in Appendix 1.<br><br>Use a container large enough to allow complete immersion of the instruments.   |
|                                   | Prepare an effective cleaning solution according to the specifications of the detergent's manufacturer using demineralized water in an appropriate container.   | The temperature of the solution shall be less than 40 °C to avoid protein fixation.  |
|                                   | If still visible, remove gross contamination using the paper wipes soaked in the cleaning solution.   | -  |
| 2.2<br>Cleaning bath              | Open devices with joints and moving parts. Fully immerse the device in the cleaning solution.   | Medical devices, e.g. with flexible shaft: It is recommended to conduct this step in an ultrasonic bath as described in sub-step 4.1. Ensure that all surfaces are thoroughly wetted with cleaning solution: <ul style="list-style-type: none"> <li>• Use a syringe to moisten all parts of the device, incl. cannulations, hinges and other shielded surfaces.</li> <li>• Ensure that no air is trapped within the features of the device.</li> <li>• Fully move devices with joints and moving parts at least 3 times.</li> <li>• Bend and rotate flexible shafts to moisten them between the windings.</li> </ul> |
|                                   | Soak the device for the time as specified by the detergent manufacturer's instructions.   |  |
| 2.3<br>Brushing                   | Required equipment: <ul style="list-style-type: none"> <li>• Soft and firm plastic brushes</li> <li>• Soft and firm plastic bottle brushes</li> <li>• Firm plastic bristle brushes</li> <li>• Plastic cleaning wires</li> <li>• Conical interdental brushes</li> </ul>  | <b>⚠ CAUTION</b> Always treat the medical device carefully to avoid surface damage. Never use metal brushes or steel wool for cleaning.  |
|                                   | Brush the device thoroughly until no contamination is visible with unaided vision. Brush bone-cutting features such as drill tips, reamer flutes and the teeth of broaches using a firm plastic bristle brush. Bend and rotate flexible shafts during brushing to remove contamination between the windings. Open / operate articulating devices and those with moving parts in order to expose all surfaces to the brushing. | Use equipment with an appropriate diameter / size for the respective device cavities and cannulations.   |
|                                   | Brush cannulations using a bottle brush. Ensure that the brush passes the whole length of each cannulation at least three times.  | Pay particular attention to rough surfaces and features that may be shielded from the brushing action. Pay particular attention to blind holes as well as hinges and joints between mating parts.<br><br>Use a bottle brush with an appropriate diameter / size for the respective cannulations.   |

### 3. Cleaning

| Sub-step                 | Description / Equipment / Parameters  | Additional information |
|--------------------------|---|------------------------|
| 2.4<br>Rinsing           | Required equipment and media: <ul style="list-style-type: none"> <li>• Running water: Sterile or germ-free with less than 10 germs/ml or endotoxin-free with less than 0.25 endotoxins/ml, e.g. purified water or highly purified water</li> <li>• Syringes: Volume 1 to 50 ml depending on the size of the feature to be rinsed</li> </ul> | -                      |
|                          | Rinse the device under running water for at least 1 min until all traces of cleaning solution are removed. Bend and rotate flexible shafts during rinsing to remove contamination between the windings.   | -                      |
|                          | Rinse cannulations, blind holes, hinges, joints and similar at least three times using a syringe.   | -                      |
| 2.5<br>Visual inspection | Visually inspect for any remaining contamination and repeat the pre-cleaning steps if necessary.  | -                      |
| 2.6<br>Drying            | Required equipment: <ul style="list-style-type: none"> <li>• Absorbent lint-free paper wipes</li> </ul>   | -                      |
|                          | Allow the device to drain under ambient conditions on absorbent lint-free paper wipes or transfer immediately to the next cleaning step.  | -                      |

### 3. Cleaning

#### Automated cleaning and disinfection

| Sub-step                           | Description / Equipment / Parameters   | Additional information   |
|------------------------------------|--|--|
| 3.1<br>Operate washer disinfectant | Required equipment and media: <ul style="list-style-type: none"> <li>• Washer-disinfectant with rinsing ports as required</li> <li>• Cleaning detergent</li> <li>• Demineralized water for the washing step</li> <li>• Freshly prepared sterile or germ-free water with less than 10 germs/ml or endotoxin-free water with less than 0.25 endotoxins/ml, e.g. purified water or highly purified water for final rinsing / disinfection.</li> </ul> | Use a washer-disinfectant with fundamentally approved efficiency (e.g. CE mark or FDA approval according to ISO 15883 series), properly installed, qualified and regularly subjected to maintenance and testing.<br><br>Cleaning detergent intended for automated cleaning which meets the criteria given in Appendix 1, concentration as specified in the detergent manufacturer's instructions.  |
|                                    | Approved thermal disinfection program (A0 value > 3000 or – in case of older washer-disinfectant – application of at least 5 min at 90 °C); with sufficient rinsing steps and filtered air for an active drying program.   | <div style="background-color: #ffffcc; padding: 2px;"><b>⚠ CAUTION</b></div> Chemical disinfection program not recommended due to danger of remnants of the disinfectant on the medical devices.<br><br>Application of rinsing aids not recommended, danger of remnants.   |
|                                    | Load the device into the washer-disinfectant.  | Avoid contact between devices (movement during washing could cause damage and washing action could be obstructed).<br>Articulating devices should be in the open position.   |
|                                    | Connect cannulations to the rinsing ports of the washer-disinfectant.  | Arrange the device so that cannulations are not horizontal and blind holes incline downwards (to assist drainage).   |
|                                    | Operate the washer-disinfectant cycle.   | -  |
| 3.2<br>Visual inspection           | On completion unload the washer-disinfectant. Visually inspect each device for remaining contamination and dryness. If contamination remains repeat the cleaning process including the precleaning stage. Remaining wetness may be removed with medical grade compressed air, and absorbent, lint-free paper wipes (if required supplemented by post-drying at a clean place for up to 2 hours) or by heating in an oven below 110°C.              | Chemical disinfection programs are not recommended due to the potential for chemical residues to remain on the medical devices. These residues could interfere with sterilization efficacy.<br><br><div style="background-color: #0070c0; color: white; padding: 2px;"><b>NOTICE</b></div> Compliance with the specified drying temperature in the cleaning process is mandatory. A higher temperature may limit the function of the medical device. |

# 3. Cleaning

## Manual cleaning

| Sub-step                   | Description / Equipment / Parameters   | Additional information   |
|----------------------------|--|--|
| 4.1<br>Ultrasonic cleaning | Required equipment and media: <ul style="list-style-type: none"> <li>• Ultrasonic bath large enough to allow complete immersion of the device, frequency 25 – 50 kHz</li> <li>• Cleaning detergent</li> <li>• Demineralized water</li> <li>• Syringes</li> </ul>   | Cleaning detergent intended for manual cleaning and suitable for ultrasonic treatment which meets the criteria given in Appendix 1.  |
|                            | Prepare an ultrasonic bath with a cleaning solution. Concentration and temperature as specified in the detergent manufacturer’s instructions.  | -  |
|                            | Open devices with joints and moving parts.<br><br>Immerse the device completely and activate the bath for at least 15 minutes.   | Ensure that all surfaces are thoroughly wetted with cleaning solution before activating the ultrasonic bath: <ul style="list-style-type: none"> <li>• Use a syringe to moisten all parts of the device, incl. cannulations, hinges and other shielded surfaces.</li> <li>• Ensure that no air is trapped within the features of the device.</li> <li>• Fully move devices with joints and moving parts at least 3 times.</li> <li>• Bend and rotate flexible shafts to moisten them between the windings.</li> </ul> |
| 4.2<br>Brushing            | Required equipment: <ul style="list-style-type: none"> <li>• Soft and firm plastic brushes</li> <li>• Soft and firm plastic bottle brushes</li> <li>• Firm plastic bristle brushes</li> <li>• Plastic cleaning wires</li> <li>• Conical interdental brushes</li> <li>• Syringes: Volumes 1 to 50 ml depending on the size of the channels to be rinsed.</li> </ul> | <p><b>⚠ CAUTION</b> Always treat the medical device carefully to avoid surface damage. Never use metal brushes or steel wool for cleaning.</p> <p>Use equipment with an appropriate diameter / size for the respective device cavities and cannulations.</p>   |
|                            | Brush the device thoroughly until no contamination is visible anymore.   | <p>Pay particular attention to rough surfaces and features that may be shielded from the brushing action.</p> <p>Pay particular attention to cannulations and blind holes as well as hinges and joints between mating parts.</p>   |
|                            | Brush bone-cutting features such as drill tips, reamer flutes and the teeth of broaches using a firm plastic bristle brush.  | -  |
|                            | Brush cannulations using a bottle brush. Ensure that the brush passes the whole length of each cannulation at least three times.<br>Rinse cannulations at least three times with a syringe using the cleaning solution.  | Use a bottle brush with an appropriate diameter / size for the respective cannulations.  |
|                            | Bend and rotate flexible shafts during brushing to remove contamination between the windings.  | -  |

### 3. Cleaning

| Sub-step                 | Description / Equipment / Parameters  | Additional information |
|--------------------------|---|------------------------|
| 4.3<br>Rinsing           | Required equipment and media: <ul style="list-style-type: none"> <li>• Running water: Sterile or germ-free with less than 10 germs/ml or endotoxin-free with less than 0.25 endotoxins/ml, e.g. purified water or highly purified water.</li> <li>• Syringes: Volume 1 to 50 ml depending on the size of the feature to be rinsed.</li> </ul> | -                      |
|                          | Rinse the device under running water for at least 1 minute until all traces of cleaning solution are removed.<br>Bend and rotate flexible shafts during rinsing to remove contamination between the windings.   | -                      |
|                          | Rinse cannulations, blind holes, hinges, joints and similar at least three times using a syringe.   | -                      |
| 4.4<br>Visual inspection | Visually inspect the device for any remaining contamination and repeat the manual cleaning if necessary.  | -                      |
| 4.5<br>Drying            | Required equipment: <ul style="list-style-type: none"> <li>• Absorbent lint-free paper wipes</li> </ul>   | -                      |
|                          | Allow the device to drain on absorbent under ambient conditions lint-free paper wipes or transfer immediately to the next cleaning step.  | -                      |

## 3. Cleaning

### Manual disinfection

| Sub-step                 | Description / Equipment / Parameters  | Additional information  |
|--------------------------|---|---|
| 5.1<br>Disinfection bath | Required equipment and media: <ul style="list-style-type: none"> <li>• Disinfectant</li> <li>• Demineralized water</li> <li>• Container</li> <li>• Syringe: Volume 1 to 50 ml depending on the size of the feature to be rinsed</li> </ul>  | Disinfectant intended for manual disinfection and compatible with the applied cleaning detergent which meets the criteria given in Appendix 1.<br><br>Bath large enough to allow complete immersion of the device, temperature according to detergent manufacturer`s instructions.  |
|                          | Prepare a bath with a disinfectant solution concentration and temperature specified in the detergent manufacturer`s instructions.   | -   |
|                          | Immerse the device completely for at least the time specified in the detergent manufacturer`s instructions.   | Ensure that all surfaces are thoroughly wetted with cleaning solution: <ul style="list-style-type: none"> <li>• Use a syringe to moisten all parts of the device, incl. cannulations, hinges and other shielded surfaces.</li> <li>• Ensure that no air is trapped within the features of the device.</li> <li>• Fully move devices with joints and moving parts at least 3 times.</li> </ul> |
|                          | Rinse cannulations at least three times with a syringe using the disinfectant solution.   | -   |
| 5.2<br>Rinsing           | Required equipment and media: <ul style="list-style-type: none"> <li>• Running water: Sterile or germ-free with less than 10 germs/ml or endotoxin-free with less than 0.25 endotoxins/ml, e.g. purified water or highly purified water</li> <li>• Syringes: Volume 1 to 50 ml depending on the size of the feature to be rinsed</li> </ul> | -   |
|                          | Rinse for at least 1 minute under running water of the specified quality until all traces of disinfectant solution are removed.<br>Bend and rotate flexible shafts during rinsing to remove contamination between the windings.   | -   |
|                          | Rinse cannulations and blind holes as well as hinges and joints at least five times with a syringe.   | -   |
| 5.3<br>Drying            | Required equipment: <ul style="list-style-type: none"> <li>• Absorbent lint-free paper wipes</li> <li>• Oven</li> </ul>   | -   |
|                          | Dry the device using medical compressed air and absorbent lint-free single-use paper wipes (if required supplemented by post-drying at a clean place for up to 2 hours) or by heating in an oven below 110 °C.  | -   |
| 5.4<br>Visual inspection | Visually inspect the device for remaining contamination and repeat complete manual cleaning and disinfection if necessary.  | -   |

# 3. Cleaning

## Inspection

| Sub-step                                | Description / Equipment / Parameters   | Additional information  |  |
|---|--|---|--|
| 6.1<br>Visual inspection                | Visually inspect all parts of the device for visible contamination and/or corrosion and repeat cleaning and disinfection if necessary.<br><br>Confirm that no damage is present (e.g. threads, surfaces, moving parts, joints) and that medical device identification (e.g. laser engravings, printings) is clear, legible and obtain a new medical device if not. | Pay particular attention to: <ul style="list-style-type: none"> <li>• Contamination “traps” such as mating surfaces, hinges, shafts of flexible reamers.</li> <li>• Recessed features (blind holes, cannulations).</li> <li>• Features where contamination may be pressed into contact with the device, e.g. drill flutes adjacent to the cutting tip, sides of teeth on broaches and rasps.</li> </ul> |  |
|   | <b>NOTICE</b> If necessary, work lights as well as magnification aids are recommended.   |   | <b>CAUTION</b> Cutting edges should be checked for sharpness and damage. |
|   |  |   |  |
| 6.2<br>Assembly                         | If applicable, re-assemble the device.   | See instructions provided in the operative technique or separate information available from your Stryker representative.  |  |
| 6.3<br>Functional check and Maintenance | Perform functional checks and preventive maintenance as applicable (for further information see also Appendix 2):  | Straightness may be checked by simply rolling the instrument on a flat surface.   |  |
|   | <b>CAUTION</b> Check mating devices for proper assembly.   |   |  |
|   | <b>NOTICE</b> If necessary, work lights as well as magnification aids are recommended.   |   |  |
|   | <b>NOTICE</b> Check functionality of devices with moving parts; apply medical grade lubricating oil (suitable for steam sterilization, e.g. Dr. Weigert neodisher IP Spray) as required. Check straightness of rotating instruments (e.g. multiple use drill bits, reamers). Check flexible instruments, e.g. reamer shafts, for damage to the spiral element.     |   |  |



# 3. Cleaning

## End of life definition

**NOTICE**

Stryker T&E typically does not specify the maximum number of uses appropriate for a reusable medical device. When cleaned, sterilized and maintained according to the instructions provided within this document, the reusable medical device basically maintains its function and biocompatibility over the lifetime of the device.

In addition, the useful life of these devices depends on many factors including the method and duration of each use, and the handling between uses. Careful inspection and functional test of the device before use is the best method of determining the end of serviceable life for the medical device, see Appendix 2 for further details.

Please contact your Stryker representative in case a reusable device has reached the end of its serviceable life and a replacement is required.

**CAUTION**

For a device that may be impacted check that the device is not damaged to the extent that it malfunctions or that burrs have been produced that could damage tissues or surgical gloves.

# 4. Packaging

Where appropriate the cleaned, disinfected, and checked medical devices should be assembled into the dedicated trays provided. Stryker has validated the sterile packagings as listed below. Other packagings may be used, but should be validated by the health care facility, see also chapter 5 for additional information.

### Double wrapped

Stryker T&E trays should be double wrapped. In the USA, Stryker T&E recommends compliance with ANSI/AAMI ST79 and the use of FDA cleared sterilization wrap (e.g. Sterisheet 100+, green, 66 g/m<sup>2</sup>).



Fig 1: Detachable drawer tray



Fig 2: Half & full size metal tray

The packaging for terminally sterilized medical devices should fulfill the following requirements:

- EN ISO 11607
- Suitable for steam sterilization
- Sufficient protection of the instruments as well as of the sterilization packagings to prevent mechanical damage
- Grade appropriate for weight of instrument and implant tray

### Rigid sterilization container

In addition to the commonly used double wrap sterilization method, Rigid Sterilization Containers of the Aesculap JK and JN Series may be used for the same purpose to sterilize any reusable medical devices provided by Stryker T&E in stainless steel trays (see Figures 1 & 2).

The following trays do not fit within the usable space of any Aesculap JK/JN Series rigid sterilization container and shall be excluded from consideration for use:

Hoffmann LRF Circular Rings  
P/N – 4933-9-930

Hoffmann LRF Foot Rings,  
Short P/N – 4934-9-910

Hoffmann LRF Foot Rings,  
Long P/N – 4934-9-920

### NOTICE

- Trays must not be stacked within the sterilization container or sterilization wrap and in the autoclave during sterilization as doing so may negatively impact ventilation and sterilization.
- For trays that contain large polymer components Stryker T&E recommends extending the drying time to 45 minutes.
- Single products can be packaged either in double wrapped sieve baskets or peel-pouches.
- Detachable drawer trays may require a modified drying process due to load and packaging configurations. Stryker T&E recommends either extending the drying time to 45 minutes or detaching the detachable drawer trays into two pieces and placing them next to each other in a full size container. It is the hospital's responsibility to validate the appropriate drying time with the sterilization equipment used. For the use of the rigid sterilization containers please consult the instructions for use of the manufacturer (Aesculap).

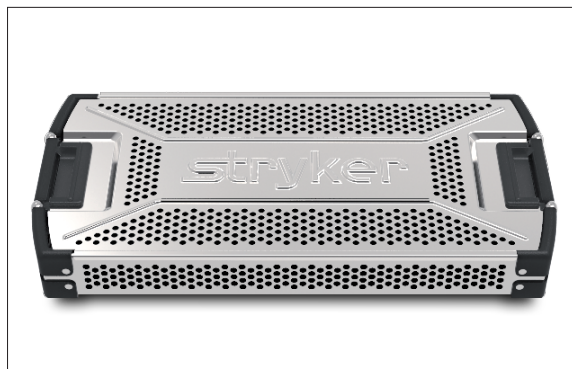

# 5. Sterilization

## NOTICE

Medical devices containing thermolabile materials must not be exposed to additional loads in the autoclave.

Steam sterilization (moist heat) is recommended.

A respective autoclave cycle has been validated by Stryker T&E as being capable of achieving sterile medical devices; however autoclave design and performance can affect the efficacy of the process. Healthcare facilities should validate sterilization equipment according to instructions from the manufacturer, and verify that sterility can be achieved using parameters supplied by Stryker T&E in combination with the equipment and processes of the healthcare facility.

## Sterilization process

Steam autoclave (moist heat) sterilization using a pre-vacuum (forced air removal) cycle is recommended. Autoclaves should comply with the requirements of, and be validated, maintained and checked in accordance with EN 285/EN 13060, EN ISO 17665, and ANSI AAMI ST79.

Stryker T&E has validated an autoclave cycle for sterilization of complete medical device cases/trays. Instruments shall be sterilized in the mounting condition as stored on the tray, i.e. if the brackets or recessions in the tray are designed to accommodate multi-component instruments in their assembled state, there is no need to disassemble these instruments for sterilization. The process parameters shown on the next page are validated and recommended by Stryker T&E for sterilization.

Stryker T&E does not recommend the use of 'flash' sterilization for reusable instruments.

## WARNING

- Do not use rigid containers for steam sterilization unless it has been validated by Stryker T&E (see approved configurations in chapter 4 "Packaging"). Other configurations could limit steam penetration and prevent effective sterilization and drying of the medical devices.
- Single use devices cannot be reused, as they are not designed to perform as intended after the first usage. Mechanical, physical or chemical properties of single use device may be compromised after first usage. In this case, the safety and performance of the devices are not supported by the manufacturer, compliance to relevant specifications cannot be ensured.

Final responsibility for verifying sterility, using the equipment and processes of the healthcare facility, and the parameters supplied by Stryker T&E, lies with the healthcare facility. To ensure optimal processing all cycles and methods should be validated for different sterilization chambers, wrapping methods and/or various load configurations.

# 5. Sterilization

\* These parameters are not applicable to the entire Stryker T&E portfolio. There are exceptions for which other validated sterilization cycles are applicable. These are described in the instructions for use and have binding character. If a product is supplied without a package insert and if you are in doubt about the applicable sterilization parameters for a particular product, please contact your Stryker representative.

<sup>1</sup> **Exposure time:**

Period for which the load and entire chamber is maintained at the sterilization temperature

<sup>2</sup> **Drying time:**

Period during which steam is removed from the chamber and the chamber pressure is reduced to permit the evaporation of condensate from the load either by prolonged evacuation or by the injection and extraction of hot air or other gases. Because drying time varies due to load configuration, wrapping method and material, the healthcare facility should verify the appropriate drying time, with the sterilization equipment used.

| USA*                       |   |
|----------------------------|---|
| Method                     | Moist heat sterilization according to EN ISO 17665 and ANSI/AAMI ST79 |
| Cycle                      | Pre-Vacuum (Pre-Vac)  |
| Temperature                | 270 °F (132 °C)   |
| Exposure time <sup>1</sup> | 4 minutes   |
| Drying time <sup>2</sup>   | 30 minutes (minimum, in chamber)                                      |
| Cool time                  | 60 minutes (minimum, at room temperature)                             |

| Outside USA*               |   |
|----------------------------|---|
| Method                     | Moist heat sterilization according to EN ISO 17665  |
| Cycle                      | Saturated steam with fractional forced air removal  |
| Exposure time <sup>1</sup> | 4 minutes<br>Exposure time can be extended to 18 minutes to comply with the recommendations from World Health Organization (WHO), Robert Koch Institute (RKI) etc. Stryker T&E medical devices are able to sustain such sterilization cycles. |
| Temperature                | 132 °C – 137 °C (270 °F – 277 °F)   |
| Drying time <sup>2</sup>   | Recommended: 30 minutes (minimum, in chamber)   |

| EU, Alternative (e.g. UK, NL)* |   |
|--------------------------------|---|
| Method                         | Moist heat sterilization according to EN ISO 17665  |
| Cycle                          | Saturated steam with fractional forced air removal  |
| Exposure Time <sup>1</sup>     | 3 minutes<br>Exposure time can be extended to 18 minutes to comply with the recommendations from World Health Organization (WHO), Robert Koch Institute (RKI) etc. Stryker T&E medical devices are able to sustain such sterilization cycles. |
| Temperature                    | 134 °C – 138 °C (273 °F – 280 °F)   |
| Drying Time <sup>2</sup>       | Recommended: 30 minutes (minimum, in chamber)   |

## 6. Storage

### before use

After sterilization, please store the medical devices in the sterilization packagings in a dry and dust-free place.

The shelf life depends on the sterile barrier employed, storage manner, environmental and handling conditions.

A maximum shelf life for sterilized medical devices before use should be defined by each healthcare facility.

## 7. Manufacturers

### of Stryker T&E medical devices

#### **Stryker Trauma GmbH**

Prof.-Küntscher-Str. 1 - 5  
D-24232 Schönkirchen

#### **Germany**

phone: +49-4348-702 0

#### **Stryker GmbH**

Bohnackerweg 1  
CH-2545 Selzach

#### **Switzerland**

phone: +41-32-641 6666

## 8. References

(for some countries only)

1. EN ISO 11607 (ANSI AAMI ISO 11607): Packaging for terminally sterilized medical devices
2. EN ISO 17665 (ANSI AAMI ISO 17665): Sterilization of health care products, moist heat
3. ISO 15883 series: Washer-disinfectors
4. ANSI/AAMI ST77: Containment devices for reusable medical device sterilization.
5. ANSI/AAMI ST79: Comprehensive guide to steam sterilization and sterility assurance in health care facilities
6. EN ISO 17664: Processing of health care products – Information to be provided by the medical device manufacturer for the processing of medical devices
7. ANSI AAMI ST81: Sterilization Of Medical Devices - Information To Be Provided By The Manufacturer For The Processing Of Resterilizable Medical Devices
8. World Health Organization (WHO) and Robert Koch Institute (RKI) recommendations regarding exposure time: WHO/CDS/CSR/APH/2000.3, Annex III, section 2,
9. RKI Communication in "Bundesgesundheitsblatt", April 2002, 45:376-394, table 11
10. Verbund für angewandte Hygiene e.V. (VAH) Desinfektionsmittel-Liste, (VAH List of Disinfectants, replaced the DGHM List of Disinfectants)

# Appendix 1

## Cleaning detergents and disinfectants used during validation of the processing instructions

For cleaning and/or disinfection of medical devices manufactured from aluminium alloys a pH neutral detergent should be used\*. Contact with strong alkaline detergents or solutions containing iodine or chlorine should be avoided, since the aluminium can be chemically attacked and the instrument may be damaged.

For automatic (washer-disinfector) cleaning mild alkaline detergents (up to pH 10.9) should be preferred, however use only detergents recommended for use in these machines.

In all cases:

- follow the indications, instructions and warnings provided by the supplier of the cleaning detergent and/or disinfectant,
- select only detergents intended for cleaning and/or disinfection of medical devices made of metals and plastics, and
- select only disinfectants with approved efficiency (VAH/DGHM or FDA approval or CE mark)

### NOTICE

Ensure that the substances listed below are not ingredients of the cleaning or disinfection detergent chosen:

- organic, mineral, and oxidizing acids (minimum admitted pH-value 5.5)
- strong lye (maximum admitted pH-value 10.9\*)
- organic solvents (for example: acetone, ether, alcohol, benzine)
- oxidizing detergents (for example: peroxides, hypochloride)
- halogens (chlorine, iodine, bromine)
- aromated, halogenated hydrocarbons

### NOTICE

- The cleaning detergents listed below were used by Stryker T&E when validating the instructions for processing provided in this document.
- Stryker T&E does not recommend these products in preference to others that are available. Other products may perform equally in conjunction with the equipment being used.
- The instructions provided by the supplier of the detergents should be followed.

- Personal protection for operators should be provided in accordance with the supplier's instructions and safety data sheets.
- Suitability of alternative detergents should be checked by reference to the supplier's information and/or physical testing.

### Detergents for pre-cleaning and manual cleaning (used for validation)

| Supplier            | Designation    | Comment                            |
|---------------------|----------------|------------------------------------|
| Johnson and Johnson | Cidezyme/Enzol | Suitable for aluminium instruments |

### Detergents for manual disinfection (used for validation)

| Supplier            | Designation | Comment                            |
|---------------------|-------------|------------------------------------|
| Johnson and Johnson | Cidex OPA   | Suitable for aluminium instruments |

### Detergents for automatic cleaning/disinfection in a washer disinfector (used for validation)

| Supplier    | Designation               | Comment  |
|-------------|---------------------------|--|
| Dr. Weigert | neodisher Mediclean forte | Not recommended for aluminium medical devices* |

\* In case of aluminium instruments neutral/enzymatic detergents are recommended (for example Neodisher Medizym).

# Appendix 2

Guidelines to check proper functionality of Stryker T&E medical devices

## Functional check for multiple use drill bits

The following guidelines should be applied to all Stryker T&E instruments which are labeled for multiple use. All functional checks and inspections described below also cover the interfaces with other instruments or components.

The failure modes below may be caused by end of life of the medical device, improper use or improper maintenance. Stryker T&E does not typically specify the maximum number of uses for reusable medical devices. The useful life of these devices depends on many factors including the method and duration of each use, and the handling between uses. Careful inspection and functional test of the device before use is the best method of determining the end of serviceable life for the medical device. However, for certain instruments end of life has been defined, verified and specified with either a number of uses or an expiration date.

**Description and function:**  
Multiple use drill bits, cannulated drill bits, burrs, taps, core drills

**Product group:**  
Complex / multi-component medical devices with challenging features

- Potential failure modes:**
- Defective coupling end (eroded)
  - Blunt and dull cutting flutes
  - Tips, helix coil, bent

**Preventive maintenance:**

**CAUTION**  
Regular functional check and visual inspection. In case of failure, the instrument must be replaced and not be used.

**NOTICE**  
If necessary, work lights as well as magnification aids are recommended.

## Drill bit: Overview

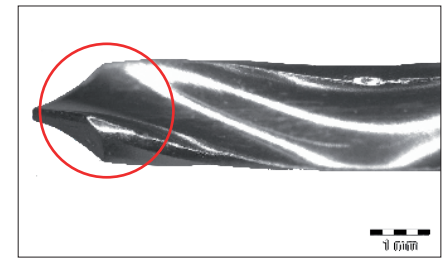

**Drill bit: blunt / dull cutting flutes**

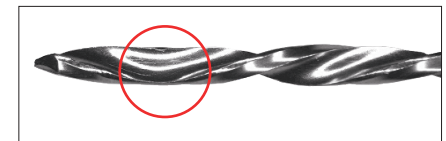

**Drill bit: helix coil - the cutting flutes change direction**

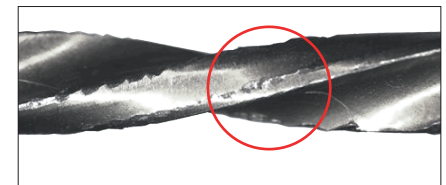

**Drill bit: blunt / dull cutting flutes and helix**

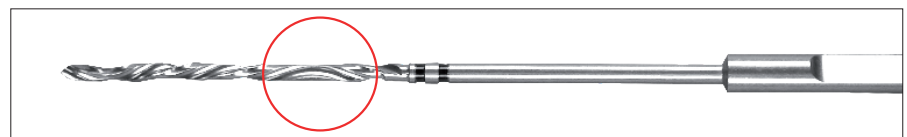

**Drill bit: twisted**

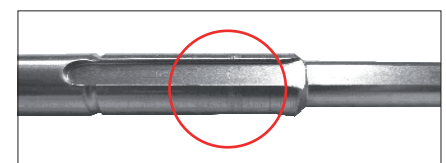

**Coupling end eroded**



**Blunt / dull tip**  
Please check at tip of drill (see mark)

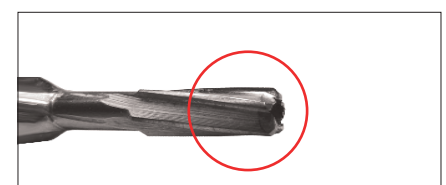

**Dents on cutting flutes**

# Appendix 2

## Functional check for medical devices with flexible shaft (e.g. reamer, flexible screwdriver)

### Description and function:

Intramedullary reamer, reamer heads, reamer shaft, flexible screwdriver

### Product group:

Medical devices with flexible shaft

### Potential failure modes:

- Defective coupling end
- Blunt and dull cutting flutes
- Tips, helix coil of reamer shaft deformed

### Preventive maintenance:

Careful inspection and functional tests of the device before preparation for sterilization is the best method of determining the end of serviceable life. Especially the spiral element should be visually checked for damage, since a deformed spiral might compromise the cleanability of the device and enable contamination to penetrate into the spiral. In case of failure, the instrument must be replaced and not be used.

If contamination is not removed from shafts right after use, incrustation is likely to occur which will be baked permanently in subsequent sterilizations.

In order to avoid damage of the flexible reamer do not overbend the shaft. As a reference the maximum bending diameter should not exceed the length divided by 2.

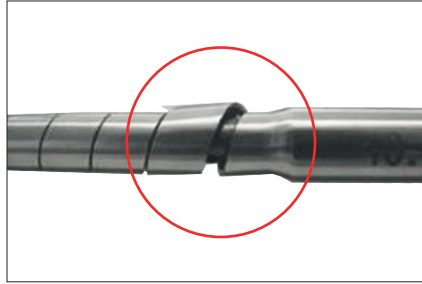

Reamer shaft: deformed

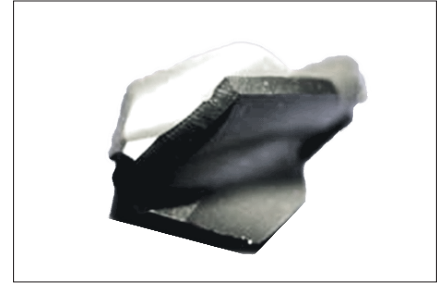

Reamer bit: blunt / dull cutting flutes

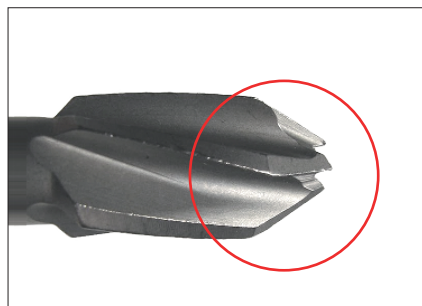
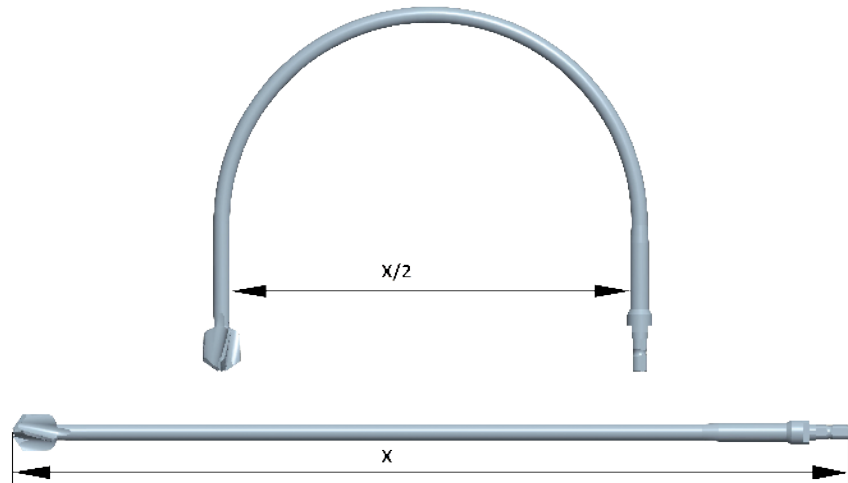

Blunt / dull cutting flutes and tip



Chunking in cutting flutes



# Appendix 2

## Functional check for screwdriver blades

### Description and function:

Screwdrivers with drive connections of various designs with or without self-retaining function.

### Product group:

Simple medical devices, complex / multi-component medical devices with challenging features

### Potential failure modes:

- Deformation of the blade (twisted)
- Deformation of the blade (rounded)
- Breakage of the blade's self-retaining mechanism without function
- Corresponding drive connection of screw head is rounded or worn.

### Preventive maintenance:

Use an appropriate instrument spray for the mechanism of the self-retaining screwdrivers. Regular functional check and visual inspection. Replace and do not use in case of failure. Regular functional check of corresponding items (screwdrivers - screws).

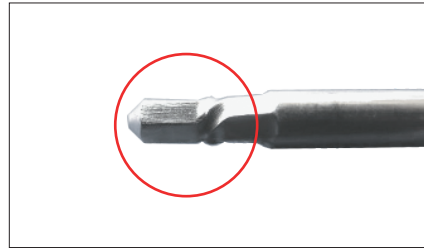

Hexagon drive connection: deformed

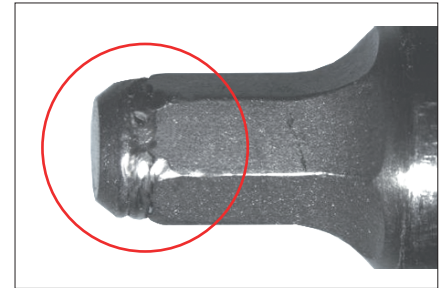

Hexagon drive connection: rounded



Connection rod of Gamma lag screwdriver: damaged and squeezed thread

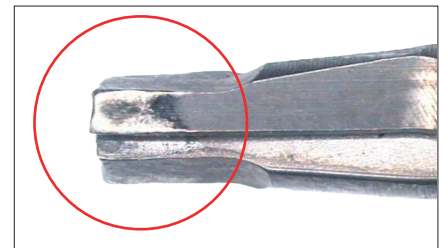

Hexagon drive connection: deformed

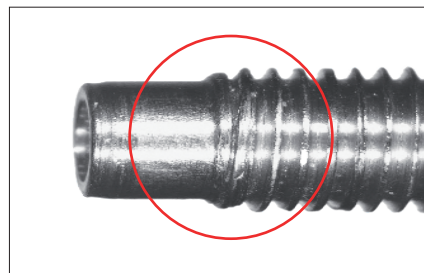

As above

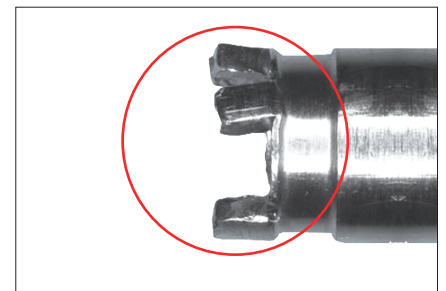

Gamma lag screwdriver: deformed/broken off pegs

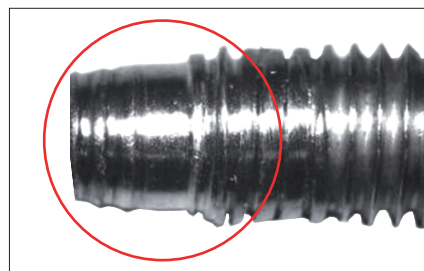

As above

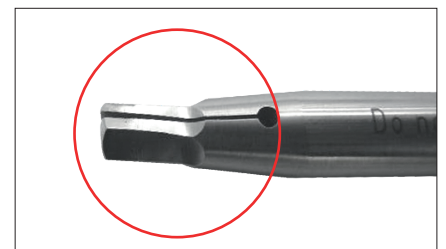

Hexagon drive connection: deformed

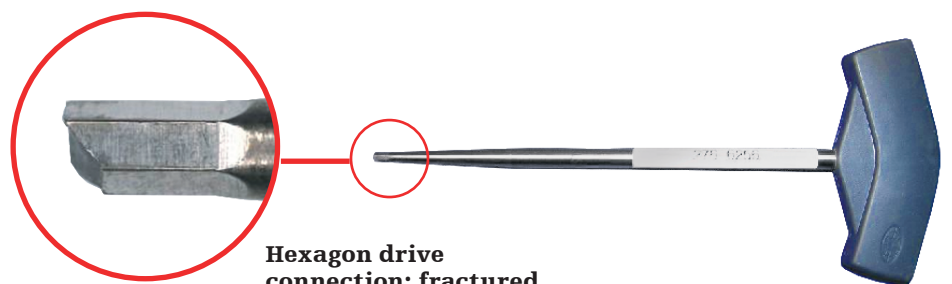

Hexagon drive connection: fractured

# Appendix 2

## Functional check for torque limiters

### Description and function:

Includes all torque limiting or indicating devices with or without a releasing mechanism.

### Product group:

Complex / multi-component medical devices with challenging features

### Potential failure modes:

- Malfunction due to wear
- Corrosion or contamination

### Preventive maintenance:

Use an appropriate instrument spray for the mechanism of the self-retaining screwdrivers. Frequent control of torque accuracy with torque tester, if indicated regular functional and visual inspection. In case of failure, the instrument must be replaced and not be used.

## Functional check for bending instruments

### Description and function:

Instruments used for bending implants

### Product group:

Complex / multi-component medical devices with challenging features

### Potential failure modes:

- Corrosion between adjacent surfaces
- Corrosion between pairings of different metals
- Corrosion on frequently used functional surfaces
- Corrosion on the laser engraving
- Bent or damaged edges imply a risk of damaging the implant, especially in functional area

### Preventive maintenance:

Regular functional check and visual inspection. Use an appropriate instrument spray for the mechanism of all moving parts and articulating surfaces. Check and if necessary eliminate all gaps for residuals and moisture after usage or cleaning. In case of failure, the instrument must be replaced and not be used.

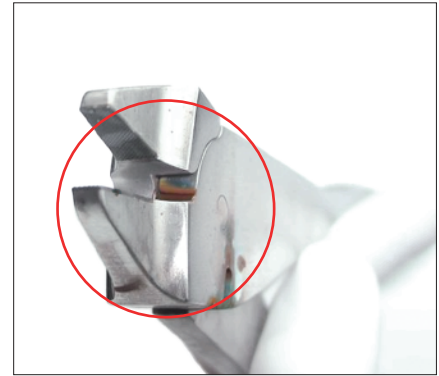

**Bending forceps with surface corrosion at cutting device and in the gap between the two parts of the forceps.**



**Slight corrosion at the laser engraving**

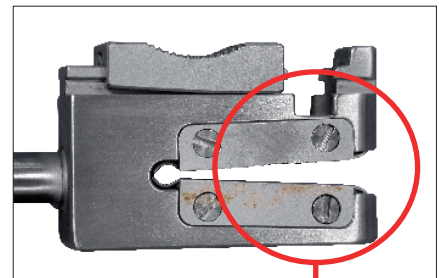

**Slight corrosion at the cutting blades**



# Appendix 2

## Functional check for scissors and cutting instruments

### Description and function:

All instrument which are used to cut tissue and bone material (like scissors or osteotomes) and also all instruments which are used to cut implants (like cutters)

### Product group:

Complex / multi-component medical devices with challenging features

### Potential failure modes:

- Cutting edge is damaged, cutting function is no longer fully given
- Spring is damaged, articulation does not work properly

### Preventive maintenance:

Use an appropriate instrument spray for the mechanism of all moving parts and articulating surfaces.

Handle the instruments with care.

The cutting edge of the instrument should be inspected prior to clinical use. The cutting function could be restricted if the cutting edge or the tip of the instrument is damaged.

Stryker T&E recommends the use of silicone-free, non-mineral oil based lubricant for the maintenance of articulated instruments. In case of failure, the instrument must be replaced and not be used.

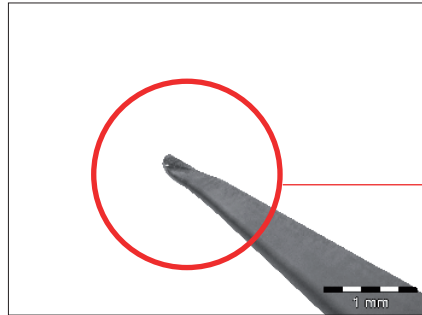

**Scissors**  
Damaged tip of a pair of scissors - cutting function could be restricted

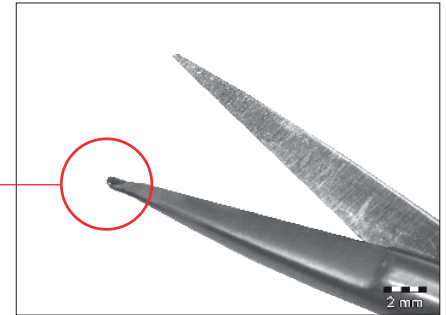

**Scissors**

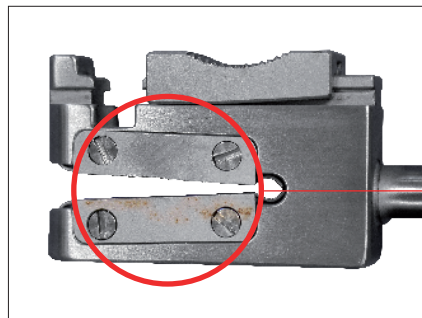

**Damaged cutting edge - cutting function could be restricted**

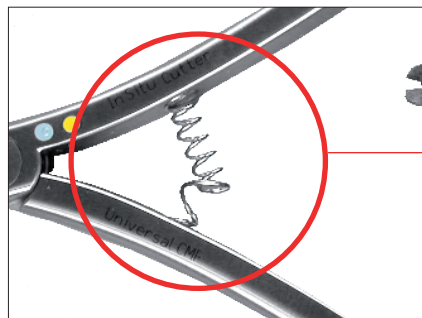

**In situ cutter**  
Damaged spring - articulation function restricted

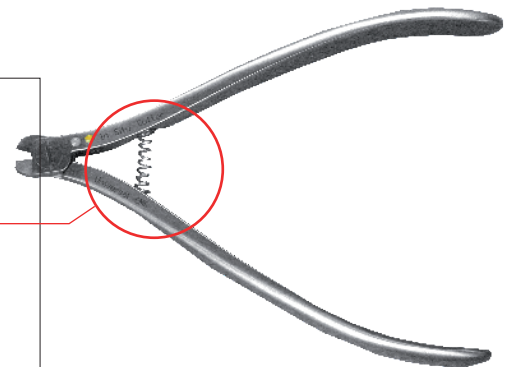

**In situ cutter**

# Appendix 2

## Functional check for targeting devices

### Description and function:

Target devices to aim at the locking holes of implants (nails, plates)

### Product group:

Complex / multi-component medical devices with challenging features

### Potential failure modes:

- Marks caused by hitting on the device
- Cracks in the polymer
- Damage of threads
- Deformation of nail adapter
- Displacement of connection pin

### Preventive maintenance:

Use an appropriate instrument spray for the mechanism of all moving parts and articulating surfaces. Handle with care. Do not hit on target devices. In case of failure, the instrument must be replaced and not be used.

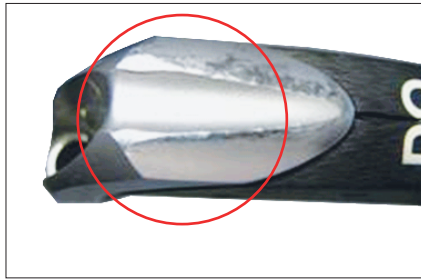

Marks on the metal part of the device

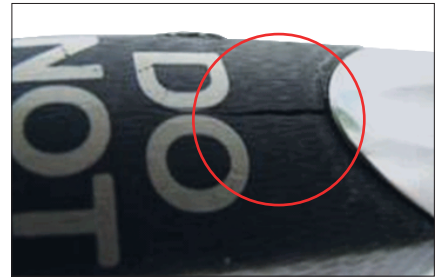

Crack in the polymer

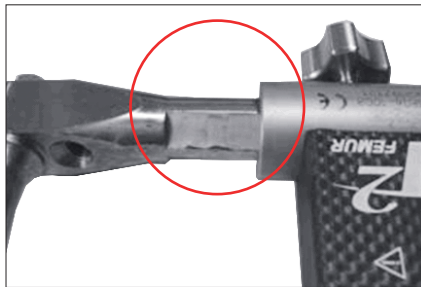

Hit marks on functional surface

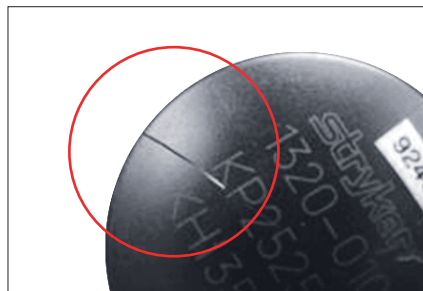
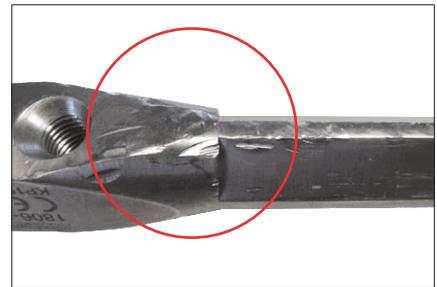

Crack

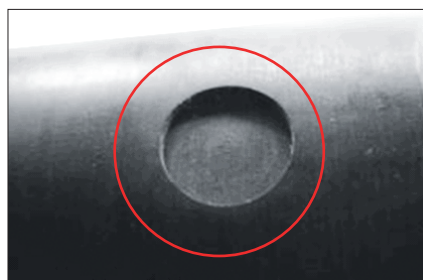

Connection pin displaced (should be flush with surface)

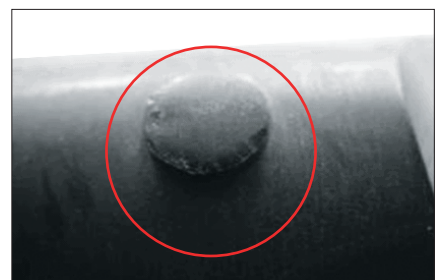

Deformation of nail adapter



Damaged threads

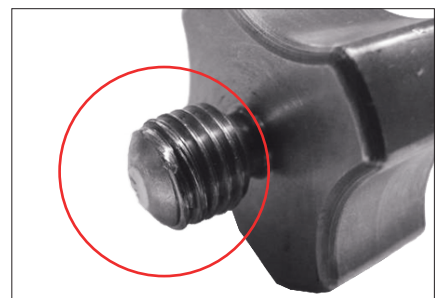

# Appendix 2

## Functional check for drill guides

**Description and function:**  
Soft tissue protection sleeves used during drilling

**Product group:**  
Complex / multi-component medical devices with challenging features

**Potential failure modes:**

- Scratched outer surfaces, dents at the sleeve tips

**Preventive maintenance:**  
Use an appropriate instrument spray for the mechanism of all moving parts and articulating surfaces. In case of failure, the instrument must be replaced and not be used.



**Drill guide: overview**

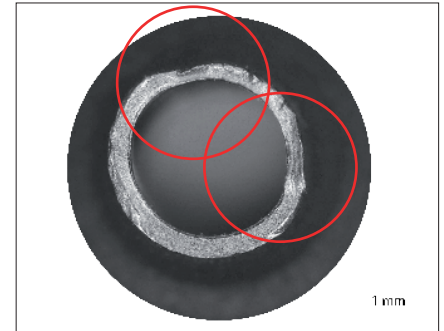

**Drill guide: dents on the drill guide tip**



**Drill guide sleeve: dents on the sleeve tip**

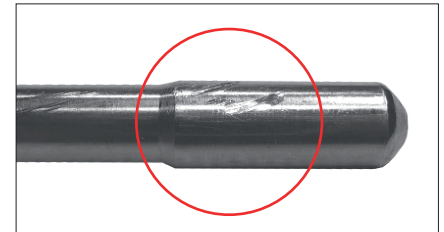

**Drill guide sleeve: scratches on the surface**



**Soft tissue protector: overview**



**Tissue protection sleeve: dents on the sleeve tip**

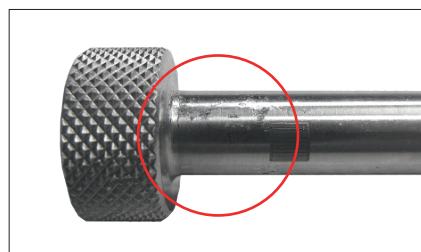

**Tissue protection sleeve: surface damaged by assembly part**

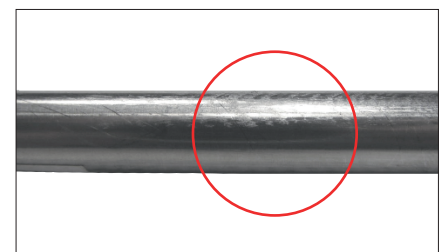

**Soft tissue protector: dents on the soft tissue protector tips**

# Appendix 2

## Functional check for forceps, clamps and holding instruments

### Description and function:

- Repositioning of bone fragments
- Clamping of wire after the wire has been put under tension with the wire tensioner

### Product group:

Complex / multi-component medical devices with challenging features

### Potential failure modes:

- Deformed functional surfaces (e.g. teeth and locking mechanism)
- Clearance between the handles
- Corrosion between adjacent surfaces
- Corrosion between pairings of different components
- Corrosion on frequently used functional surfaces
- Corrosion on the laser engraving
- Corrosion of clamping disk may lead to breakage of the disk when put under stress

### Preventive maintenance:

Use an appropriate instrument spray for the mechanism of all moving parts and articulating surfaces. In case of failure, the instrument must be replaced and not be used.

#### ⚠ CAUTION

Always examine the wire post and especially the clamping disk before reuse. In case of corrosion signs or crack, the wire post shall not be used.



Bent teeth and damaged locking mechanism on a forceps

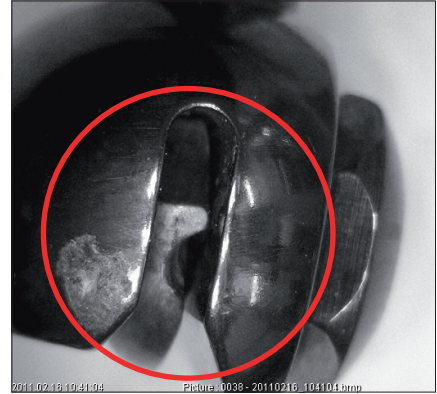

Stress corrosion on clamping disc of Tenxor wire tensioner

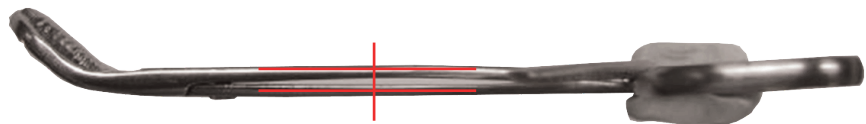
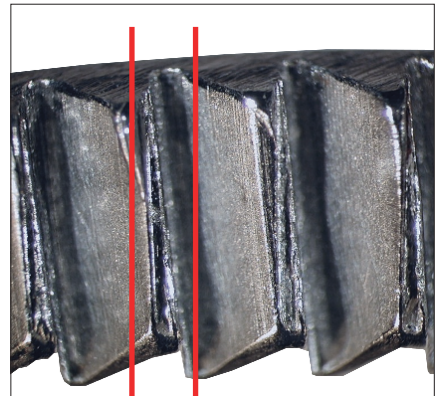

Deformed handles on a forceps

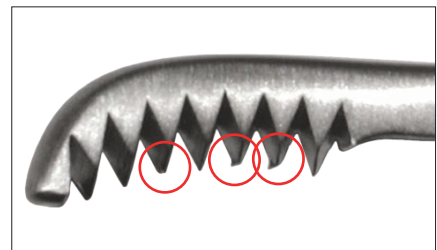

Bent teeth of a forceps

# Notes

This document is intended solely for the use of healthcare professionals. A surgeon must always rely on his or her own professional clinical judgment when deciding whether to use a particular product when treating a particular patient. Stryker does not dispense medical advice and recommends that surgeons be trained in the use of any particular product before using it in surgery. The information presented is intended to demonstrate a Stryker product. A surgeon must always refer to the package insert, product label and/or instructions for use, including the instructions for Cleaning and Sterilization (if applicable), before using any Stryker product. Products may not be available in all markets because product availability is subject to the regulatory and/or medical practices in individual markets. Please contact your Stryker representative if you have questions about the availability of Stryker products in your area.

Stryker Corporation or its divisions or other corporate affiliated entities own, use or have applied for the following trademarks or service marks: Leibinger, Stryker. All other trademarks are trademarks of their respective owners or holders.

Content ID: OT-RG-1 Rev. 8, 02-2022  
Copyright © 2022 Stryker



Stryker Trauma GmbH  
Prof.-Küntscher-Straße 1–5  
24232 Schönkirchen, Germany



Stryker GmbH  
Bohnackerweg 1  
2545 Selzach, Switzerland

[www.stryker.com](http://www.stryker.com)

CE 0123